

COLOR CODES	
B	BLUE
E	GREEN
C	BLACK
Y	BROWN
N	ORANGE
O	PURPLE
P	PURPLE
R	RED
K	RED
W	YELLOW

LEGEND	
---	CONNECTION
-	NO CONNECTION
⊘	DIODE
⊗	FUSE
⊙	SPEAKER
⊚	DUAL SWITCH
⊖	RHEOSTAT
⊕	LED
⊘	JUMPER
⊚	GROUND
⊚	CONNECTOR
⊚	2 WIRE LIGHT
⊚	3 WIRE LIGHT

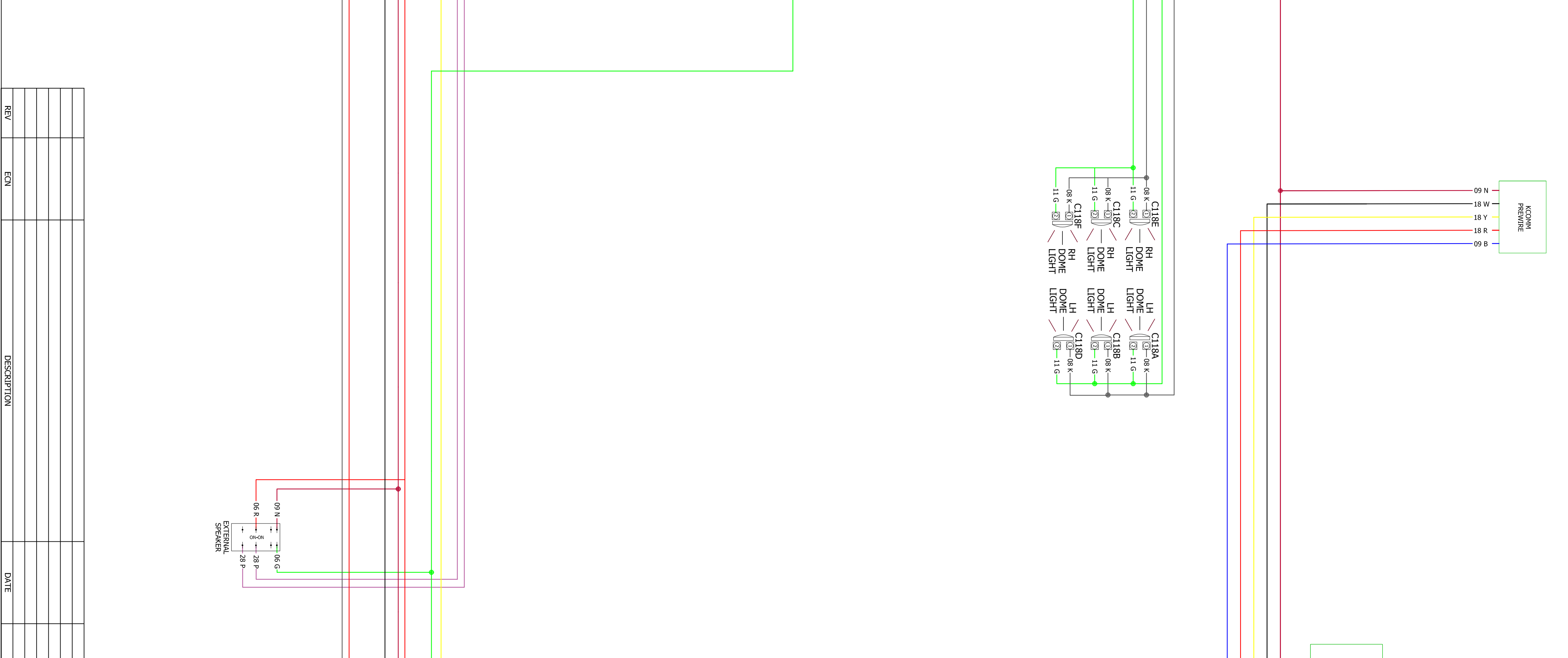
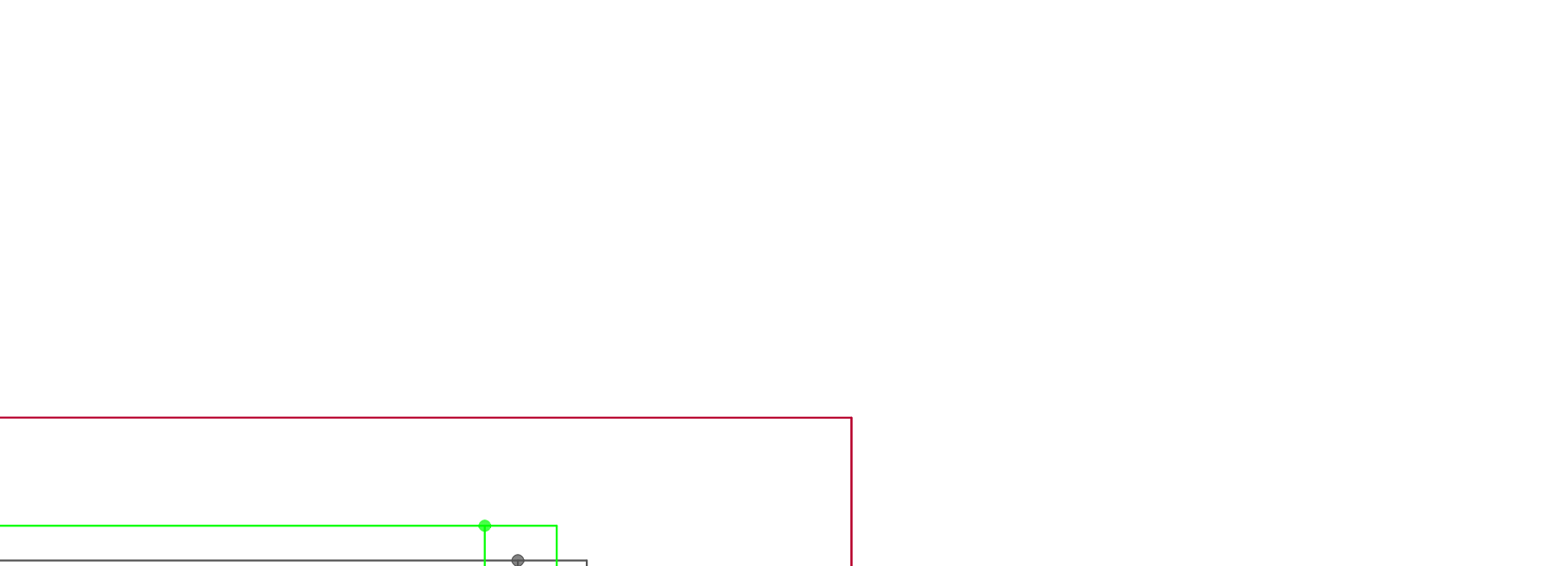
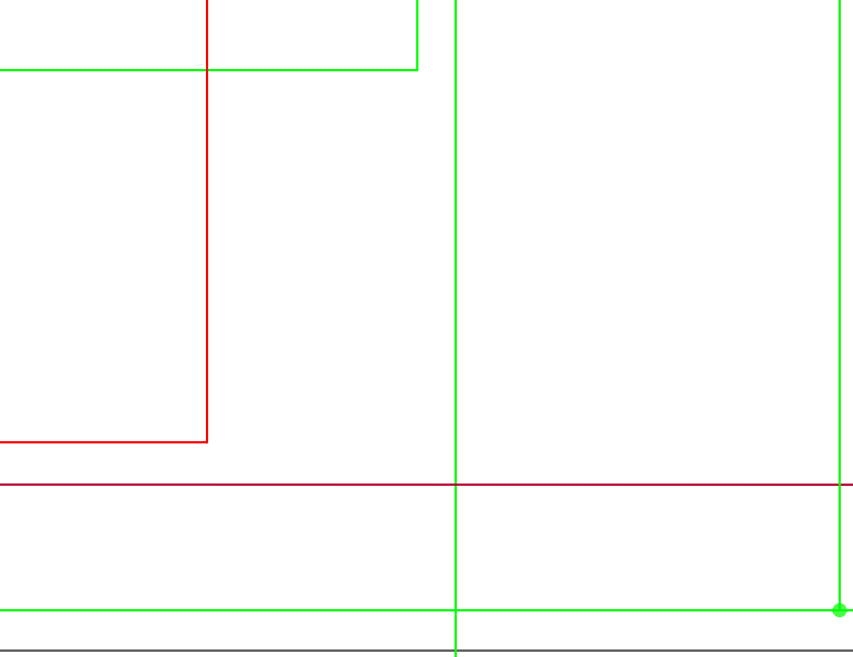
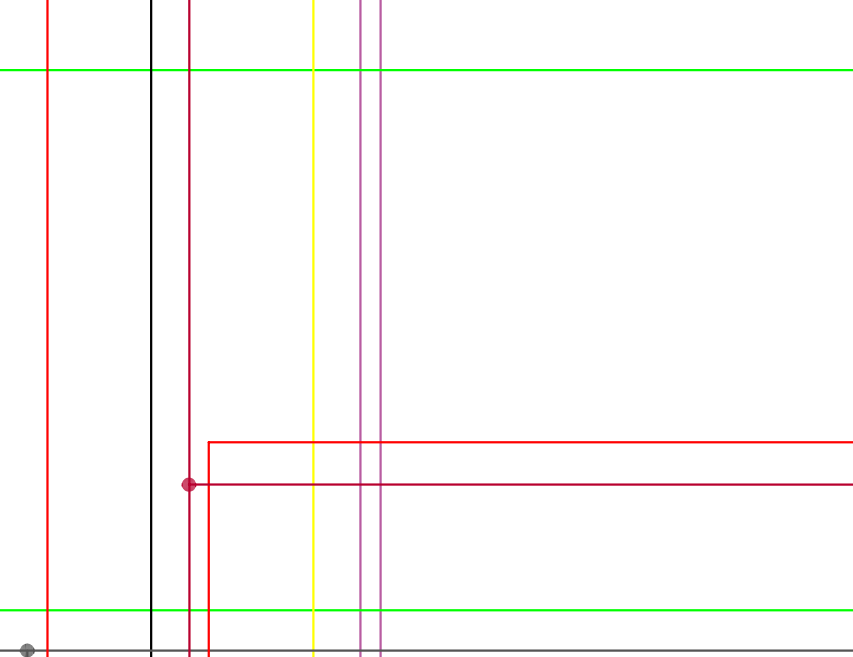
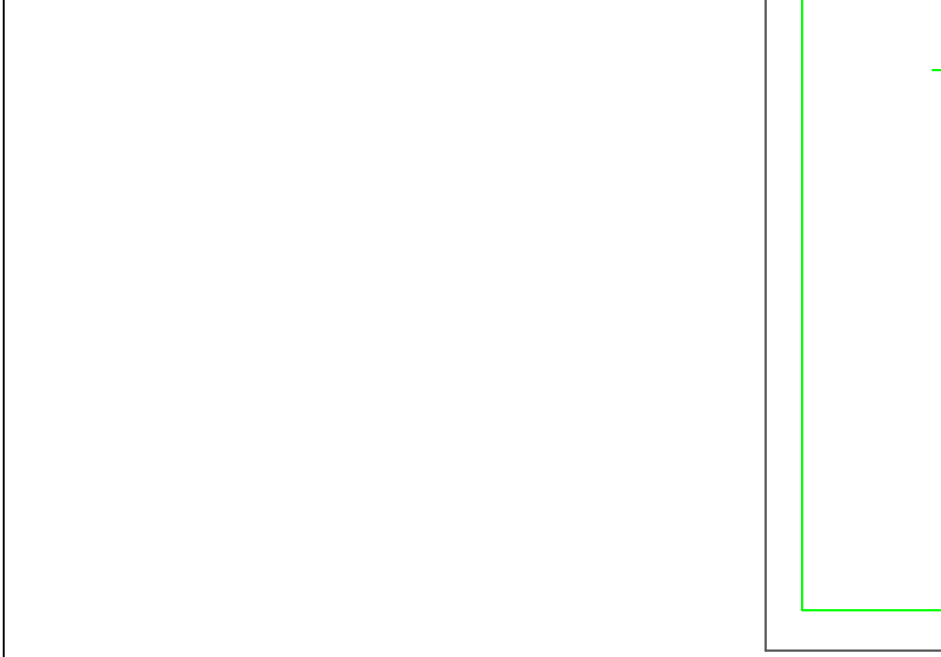
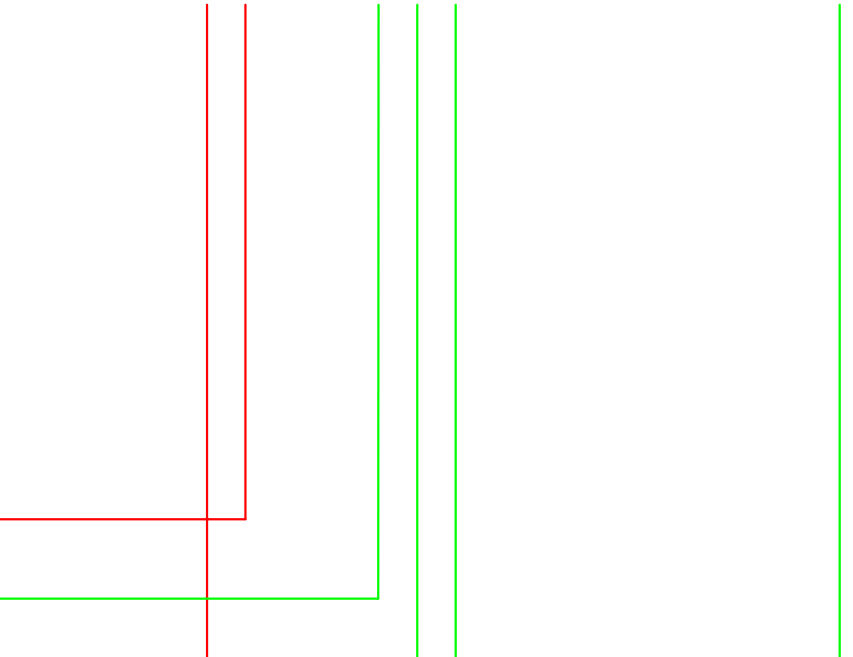
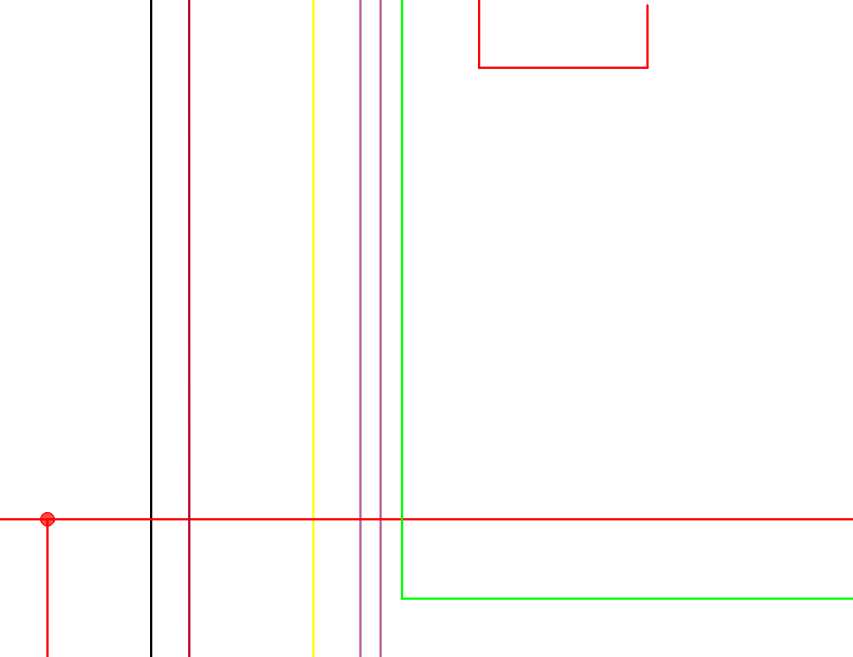
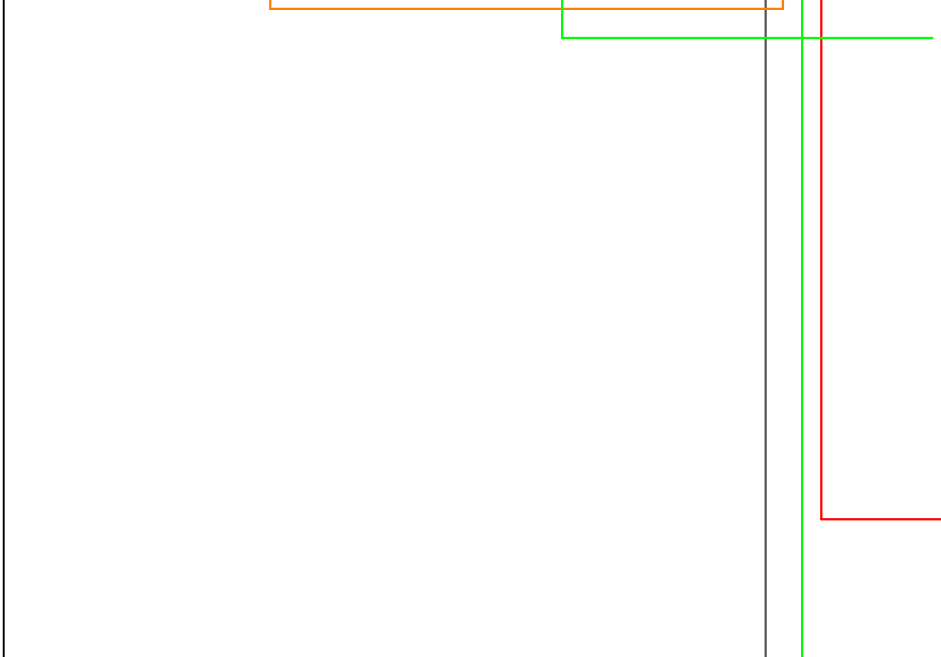
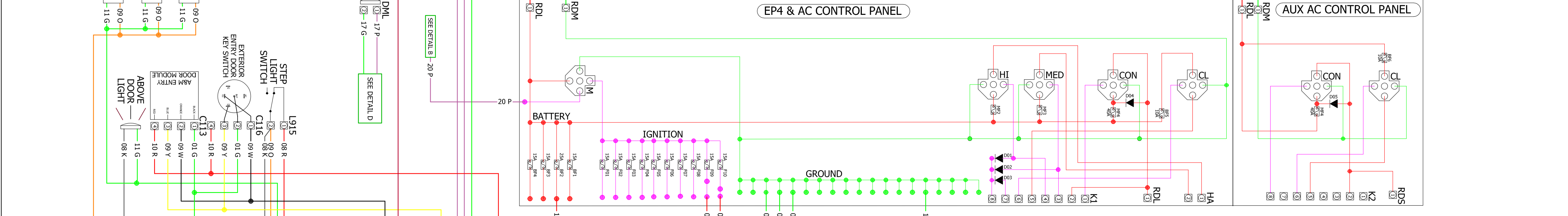
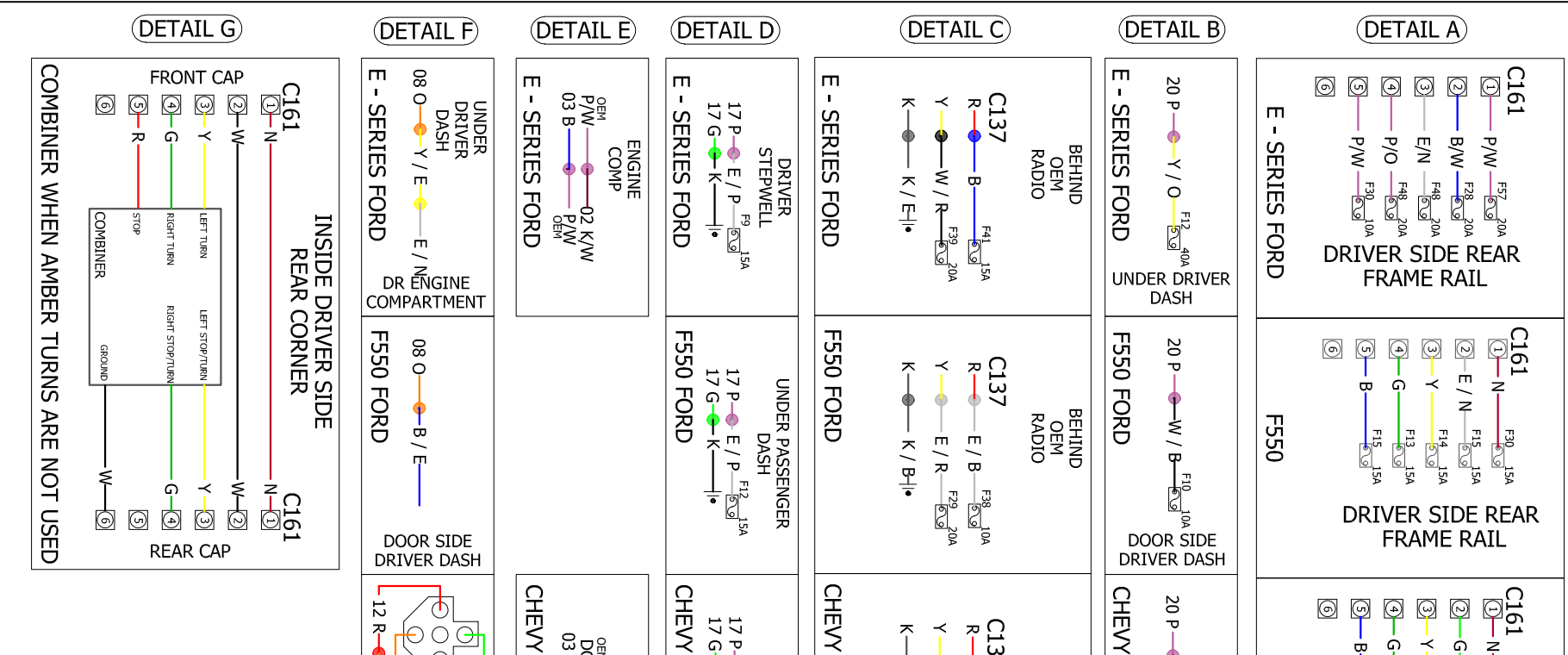
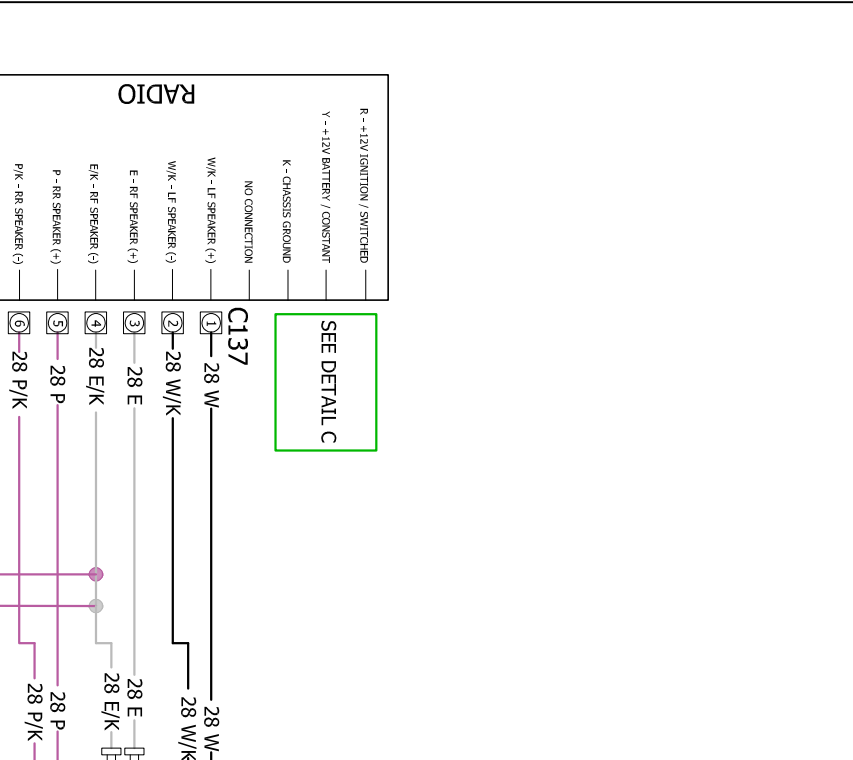
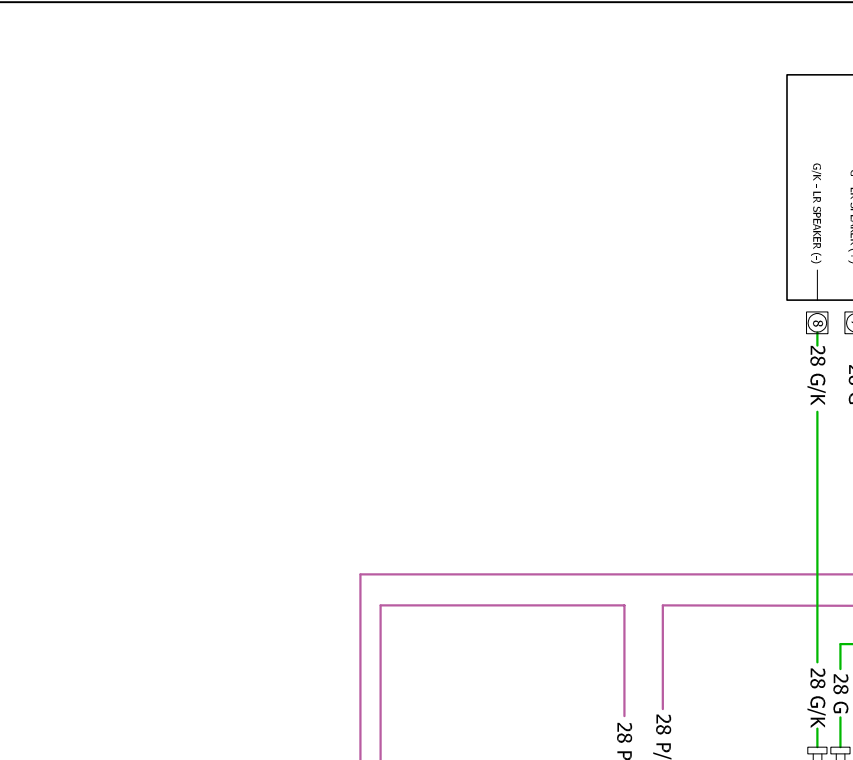
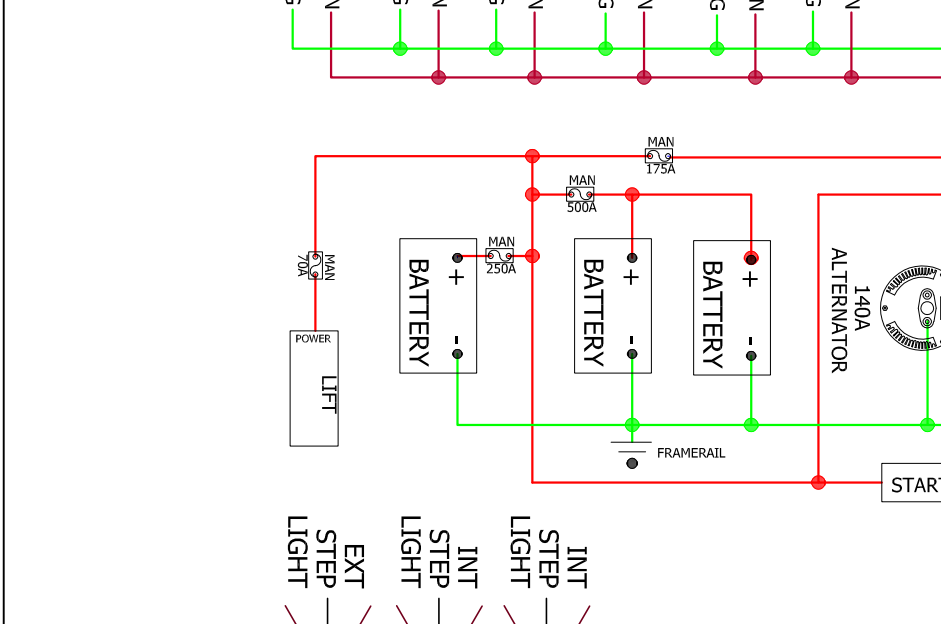

REVISION NO: **EP4 OVERALL LAYOUT**

REV	EN	DESCRIPTION	DATE	BY

MATERIAL: **SEE BOM**

TOLERANCES UNLESS NOTED XXX +.05 INCHES UNLESS NOTED ANG +.1° DIMENSIONAL INTERPRETATION AS SHOWN INTERPRETATION: AS SHOWN	DESIGNED BY: <b>Virgil Adams</b>	DRAWN BY: <b>NTS</b>
CHECKED BY: <b>E</b>	DATE: <b>12/21/2016</b>	SCALE: <b>1 OF 1</b>

PROJECT: **EP4 OVERALL LAYOUT**

